

Smart Lock User Manual



Special Attention:

1. Please keep mechanical key on hand as a failsafe in case of lock failure or emergencies.
2. Please replace all 4 batteries when the device starts to alert of low battery.
3. Read this manual carefully before installation, and keep it for future reference.

1. Lock Structure

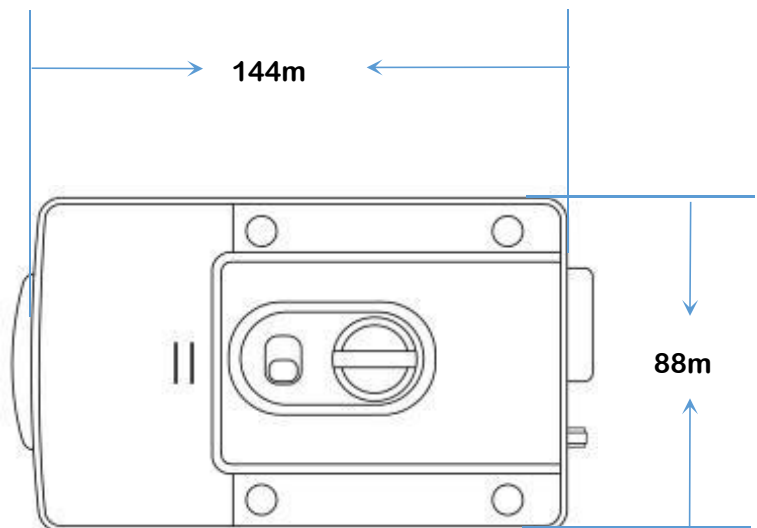
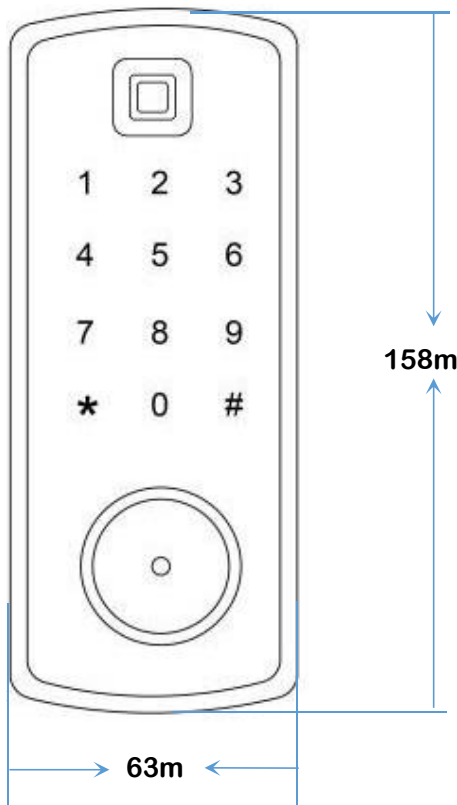
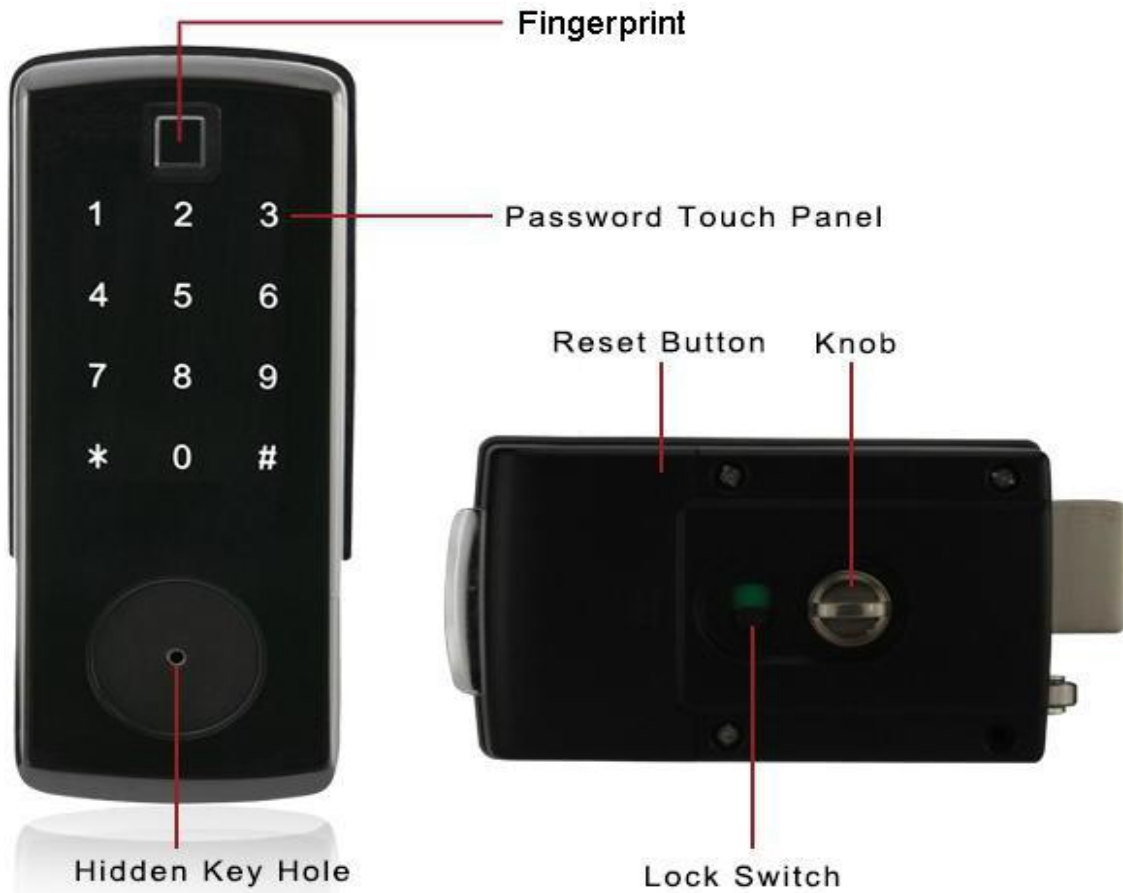

2. Installation

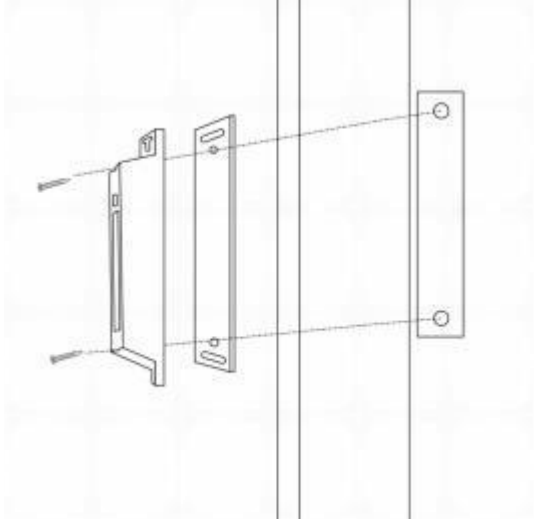
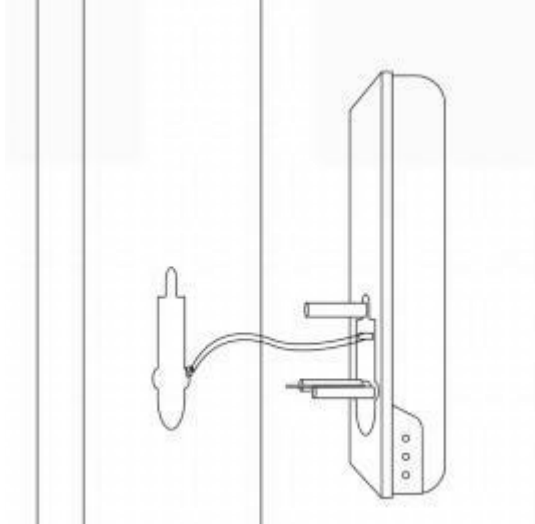
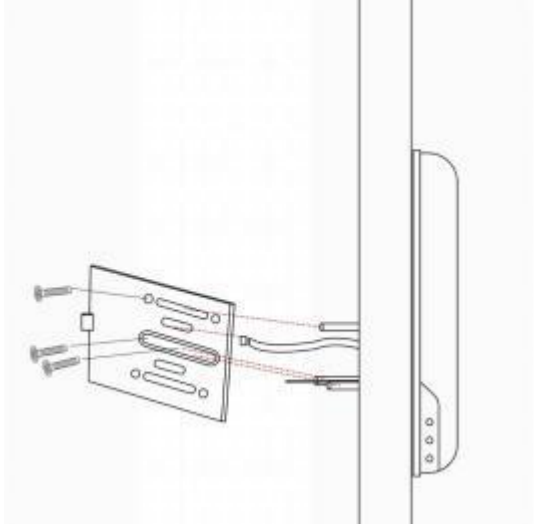
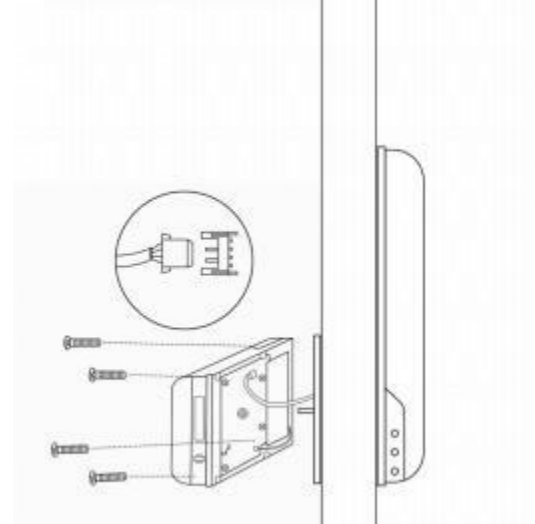
Step1 Install strike box	Step2 Install front panel
	
Step3 Fixed front panel	Step4 Install rear panel
	

3. Specifications

Suitable for Models	M02B
Materials	Zinc Alloy
Lock Size	Front: 158*63*20mm Rear: 88*144*40mm
Unlocking way	Fingerprint Password Card Mechanical key
Colour	Black
Doors Applicable	Wood Door/Iron Door
Door Thickness to Fit	30-60mm
Working Voltage	6V (4x AA Batteries)
Low Wattage Alarm	Below 4.8V
Battery Life Span	Support 10,000 Times of Locking & Unlocking Operation
Working Temperature	-20°C-70°C
Working Humidity	20%-90%
Data Capacity	100(Including admin)
Card Type	RFID
Distance to Sense Card	<25mm

4. System Reset

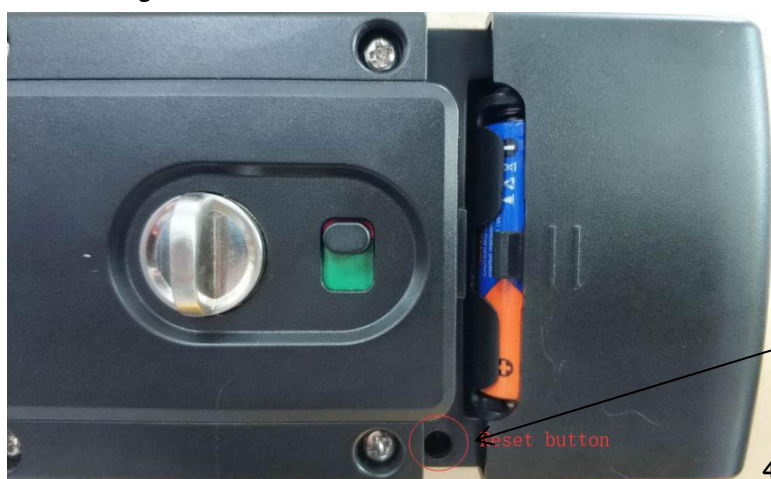

- ① Press and hold the "Reset button"
- ② Key in password "000#"

Reset Button

4.Registration



4.1 Connect lock to the phone

- 1) Android mobile phone, please scan the QR code as above
- 2) Apple mobile phone, please search “TTlock” from App Store or scan the code as above.
- 3) Register a new account (phone number or email) or login with an existing account.
- 4) Touch the lock screen, click "+ Add Lock”
- 5) Select “Door Lock”
- 6) The lock nearby will appear on the phone screen, Click "+”
- 7) Re-name the lock
- 8) The lock added successfully

③

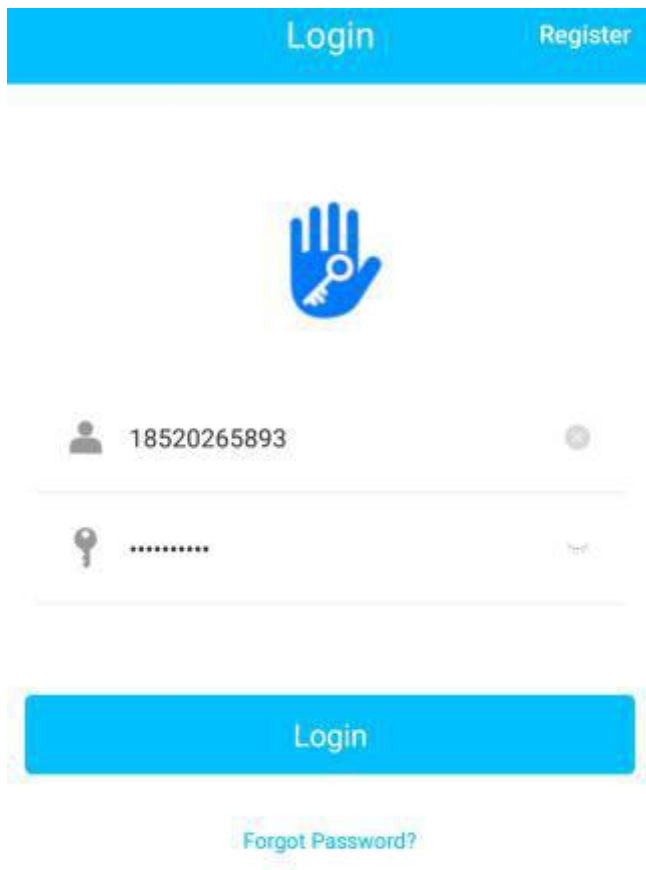

④

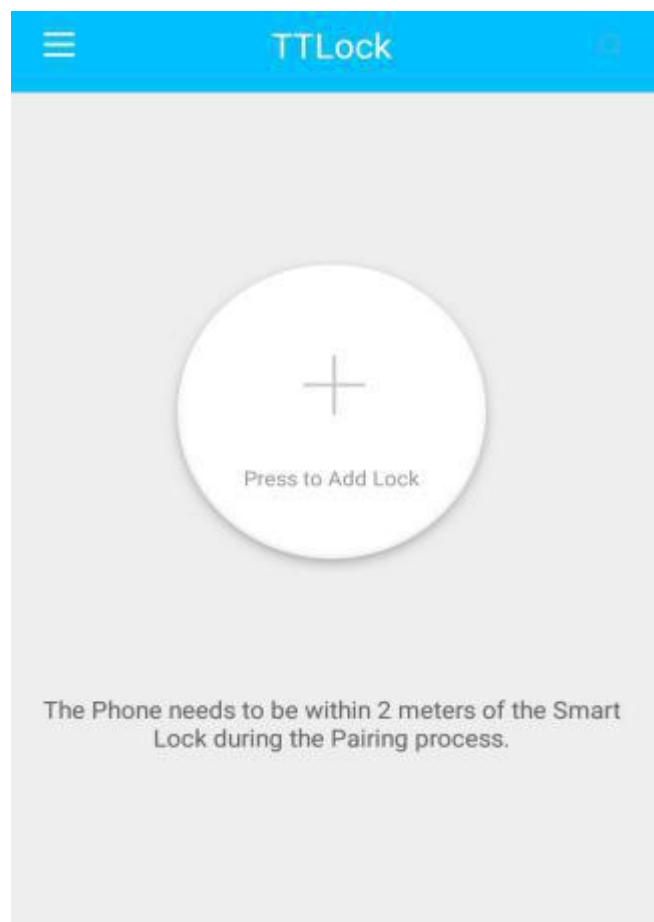

⑤

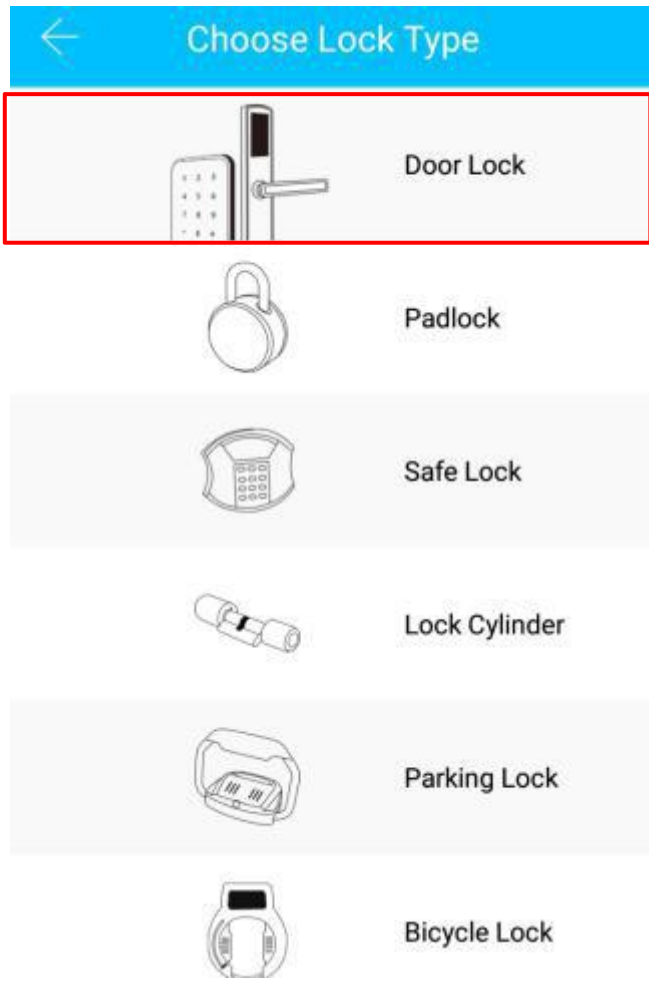

⑥

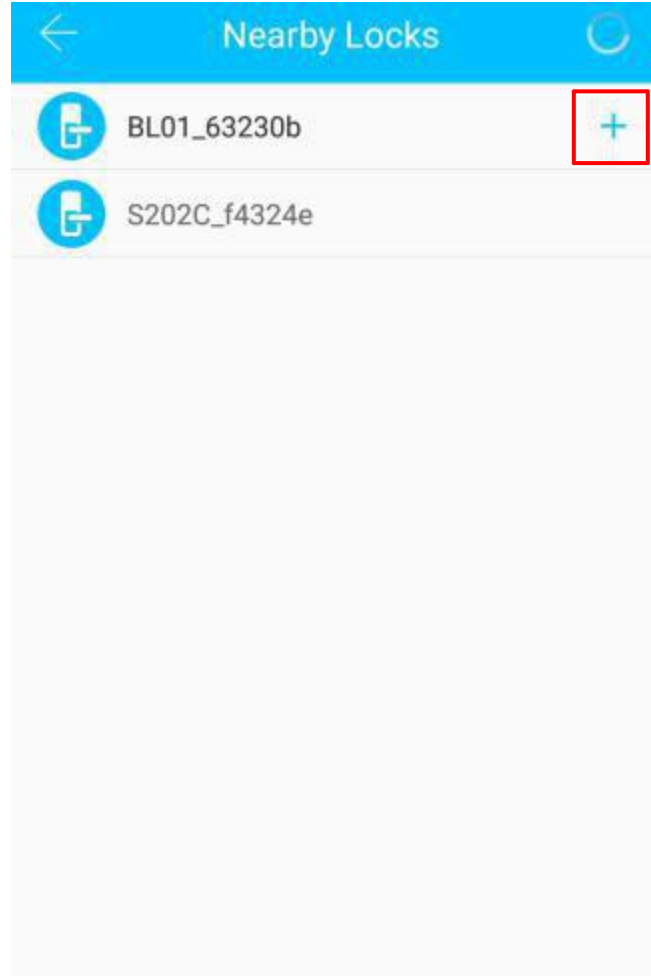

⑦

← Add Lock

Lock Name

G03B

OK

⑧

← Added Successfully

Added Successfully



Lock Name G03B

Battery  100%

Complete

4.2.1 Bluetooth unlock

Tap "" to unlock remotely. The devices must be within the Bluetooth connection range.

4.2.2 Remote control unlock

Once you activate Remote unlock function at settings, "" will appear on the main page as shown on page 8-image 2-1. You can unlock it anywhere you have a network.

Please refer to 4.3 on page 9 on setting up the gateway.

4.2.3 Bluetooth key remote authorization

Tap " Send eKey" to add permanent and temporary users and set access schedules or for specific days and time. (the receiver must download TTLock APP and register an account)

4.2.4 Set Admin passcode

Tap " Settings" → Basics → Admin passcode to set or change Admin passcode

4.2.5 Dynamic password unlock

Tap " Generate Passcode" to generate random passcode for permanent or temporary access.

4.2.6 In and out activity log

Tap " Records" to see historical data of activities.

4.2.7 Fingerprint unlock

Tap "  " to add fingerprint, you will be prompted to place your finger tip on the sensor.

4.2.8 Card unlock

Tap "  " to add RFID card, once connected, the app will prompt user to scan the card for registrations

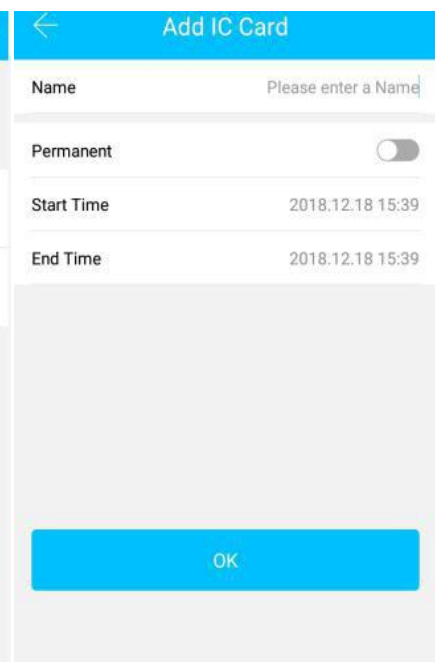
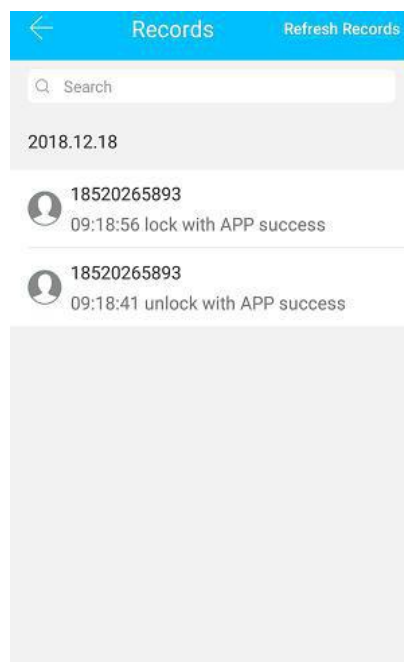
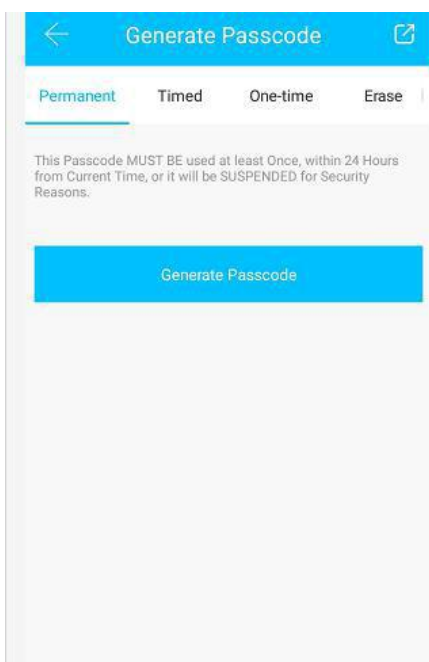
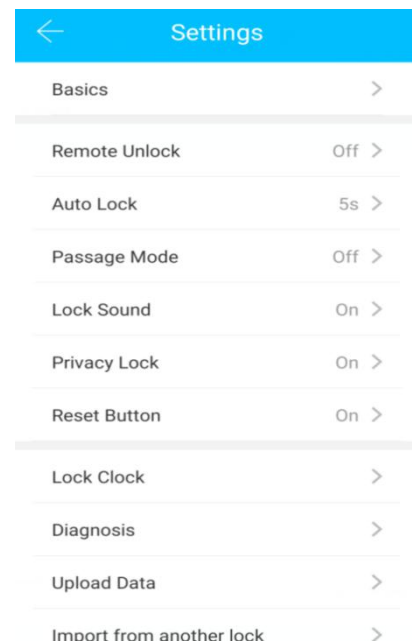
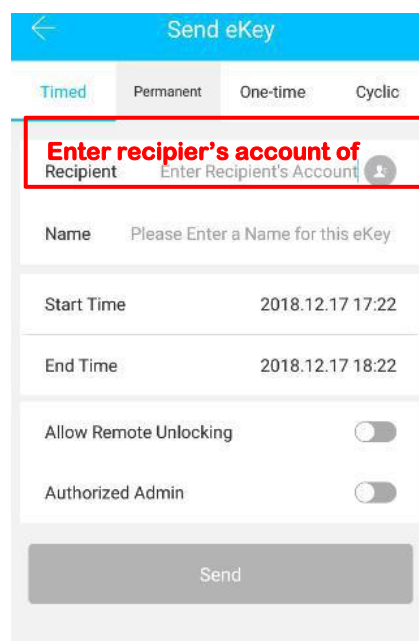
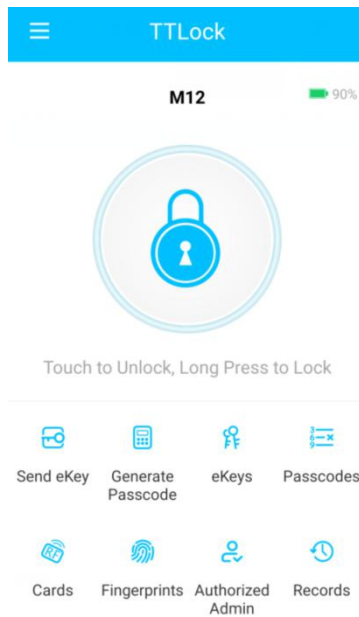



4.3 Set up the connection between the gateway and the phone(Option)

Light Status



When the gateway is powered on:

-  Light flashes alternately in red and blue: Stand-by mode, ready for pairing
-  Blue light: Working mode
-  Red light: Network failure

Pair the Gateway with APP

1 Activate the APP

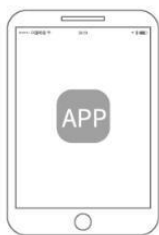

2 Press "☰"

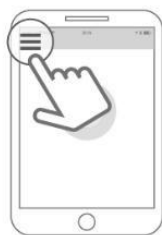

3 Select [Gateway]

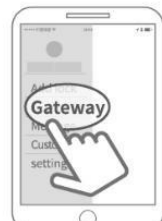

4 Select [G2]

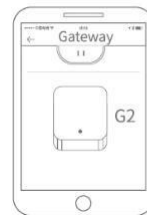

5 Plug in the gateway and power it on, while the light flashes alternately in red and blue

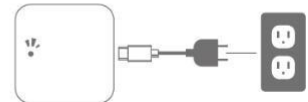

6 Press "+" sign



7 Add Gateway











8 Select the network and fill in the password

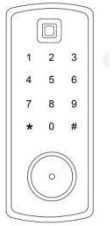
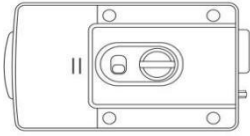
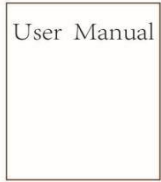
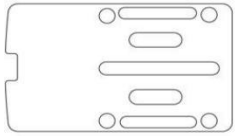

9 Add complete

⚠ Notice: If times out, please power off and try it again.

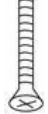
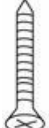
Packing List

Picture				
Name	Front Panel	Rear Panel	User Manual	Fixed iron plate
Quantity	1	1	1	1
Picture				
Name	Strike Box	Strike Box Plate	Mechanical Key	Card
Quantity	1	3	2	3
Picture				
Name	Screw 01	Screw 02	Screw 03	Screw Casing
Quantity	3	4	2	1