

1 Product Description

Generality

Aiming at the security and modern management needs of residences, offices, and smart communities, we have introduced face recognition, fingerprints, palm prints, magnetic cards, passwords and mechanical keys, using advanced, infrared cameras and color cameras to detect faces through human sensing Technical fingerprint recognition, non-contact and password as the door key, and there are multiple door opening modes to choose from, more flexible, more convenient and faster.

User type	Quantity	Remark
Administrator	9	Administrators can manage common users and change settings
General user	291	Ordinary users can use (fingerprint/password/card)

Product Picture

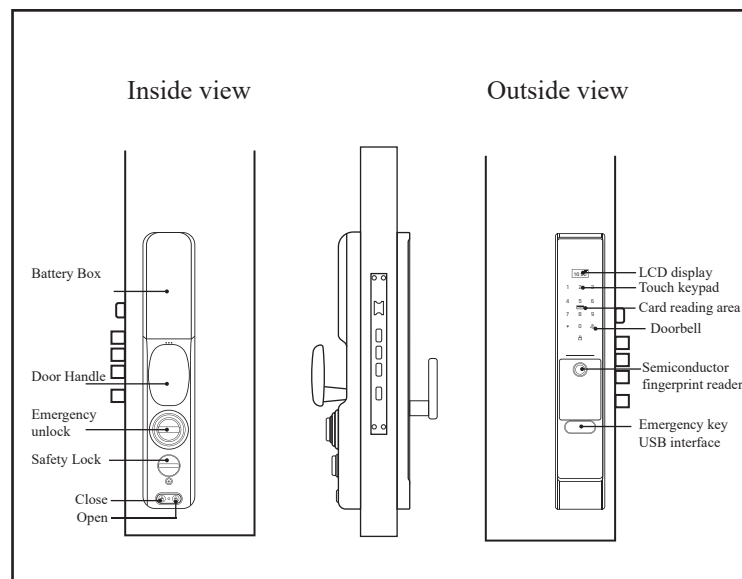

2 Product List and Installation Drawing

Please check the following list carefully after unpacking the box. If there are omissions, please ask the company or agent in time.

Serial number	Name	Quantity	Remark
1	Door Handle	2	
2	Screw Tube	2	
3	Lock Body	1	
4	Square Steel	1	
5	Metal Plate	1	
6	Battery	1	
7	Battery Cover	1	
8	Cylinder	1	
9	Lock Bolt	1	
10	Anti-lock	1	
11	Screws	2	
12	RFID Card	4	
13	USB Cable	1	

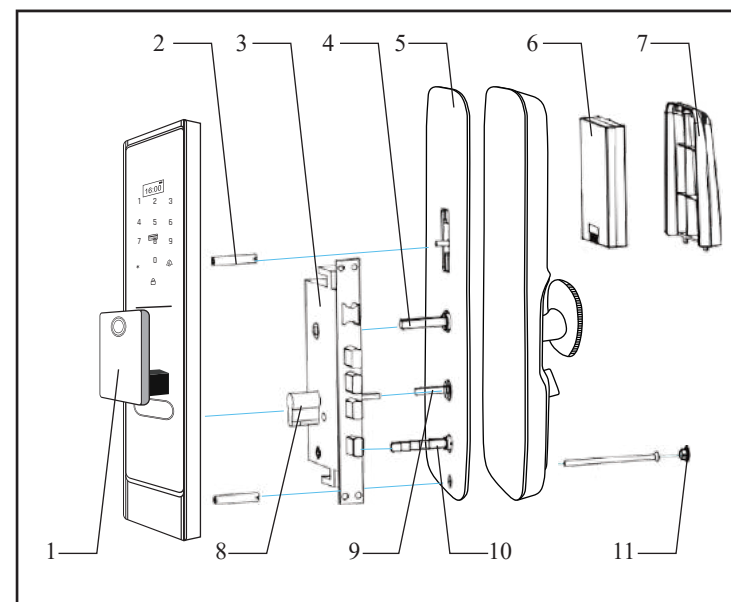

3

Before you install

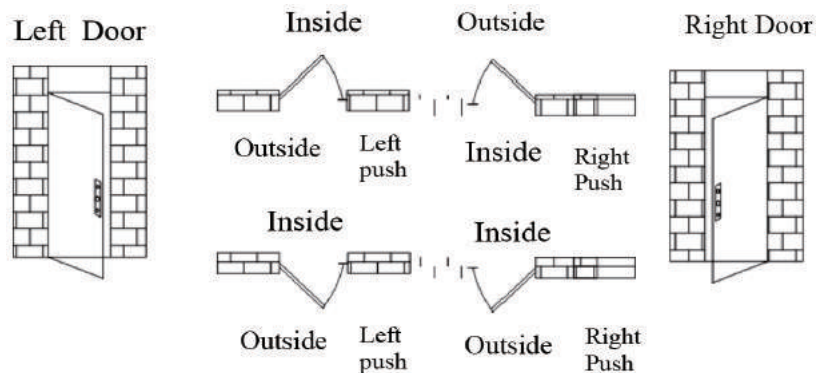

The new lock does not add any users, it can be unlock for any fingerprint / Mifare1 Card. The default password is 123456.

About Battery:

Power Charger Output: DC 5V / 2A

Please recharge the battery before using the smart lock

Door Sir Set:

Press "888#" to Install Set

Press "1" to Direction to Left / Right

Note: If the door lock opening is opposite to the operation, please adjust to another opening direction(Left / Right).

4

Installation Steps

Make hole in the door according to the opening template. Put the lock body into the door frame and tightem it with screws

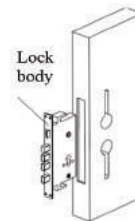

Tighten the two screws on the front panel outside

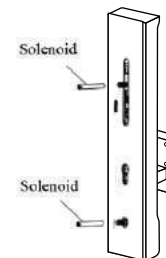

Cut the lock core according to the thickness of the door, put it in the corresponding position of the lock body, and lock it with screws. One end of the keyhole is aligned with the front lock plate.

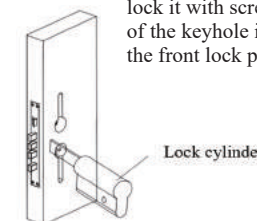

Outside, the square steel on the back lock plate and 2 fixed installation are tightened, and finally the anti-lock square iron is also installed and fastened with iron bolts

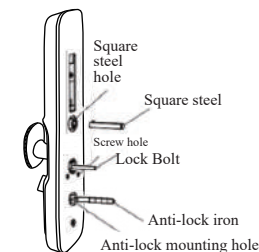

First install the installed front lock with the lock cylinder outside the door, and pass the connecting wire through the door panel.

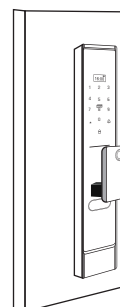

After pulling out the front lock connecting line and connecting it with the rear lock plate, as shown in the figure below, cut the square steel, the fixing rod and the tail end of the lock core to a suitable length to insert and lock the square steel with the lock body holes Finally, use screws to lock and adjust the position from the back. Put the battery on the silicone cap and use it.

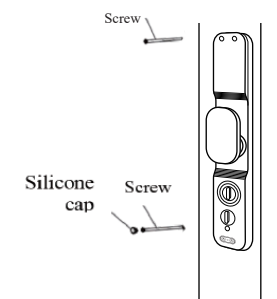

Description(Automatic models)

Fingerprint,password and magnetic card entry instructions



**Touch the wake screen to light up,press*+
to enter the function menu to verify the
entrance**

Note:

All settings and changes need to enter the function menu settings

2 means up,8 means down,# means confirm,*means to return

Add Administrator

Please add administrator password before use:

- (1) Press "*#123456#" keys to Setup menu.
- (2) Press "1" to Admin Setting, Press "1" to add admin, press 6-8 digits password, Press "#" key to confirm, and enter again.
- (3) Add other admin via Fingerprint & Password & Card.

Add User:

- (1) Press "*# admin password# keys to enter the Setup menu.
- (2) Press "2" to User Setting, Press "1" to add User (Fingerprint & Password & Card) .
- (3) Add other User via Fingerprint & Password & Card.

Delete User:

- (1) Press "*# admin password #" keys to enter the Setup menu.
- (2) Press "2" to User setting, Press "3" to Delete User.

System Setting:

- (1) Press “ * # admin password # ” keys to enter the Setup menu, Press “3” to System Setting
- (2) Press "1" to Set Date Time.
- (3) Press "2" to Unlock Mode.
- (4) Press "3" to Open Door Set. (adjust to left / right opening direction)
- (5) Press "4" to Language & Vol Setting.

Reset:

Perform a factory reset operation on the system. This operation will delete all records and settings. Please proceed with caution;

A. Press “ * # admin password # ” keys to enter the Setup menu.

Press "1" to Admin Setting, Press "4" to Factory Reset, press "#" to confirm.

B. One-click to clear: After waking up the screen, press the set button(near battery) and hold for about 10 seconds to restore the factory settings.

6

Wi-Fi Smart Network Lock APP Instructions

- 1: Search “Tuya Smart” in APP store or an App market. Download and install it.
- 2: Register using your smartphone number and log in.
- 3: Add an Administrator on smart lock, the time setting of the smart lock should be same as the smartphone time
- 4: Press “ * # admin password # ” keys to enter the Setup menu, Press “2” to User Setting, Press “4” to Manage Wireless, Press “1” to Add WIFI: Press 1 to “WIFI” configing (or Press “2” to “AP”)

Smartphone APP operation:

①:Open the Tuya App, Press Add Device



②:Security&Video Surveillance -Lock(Wifi)

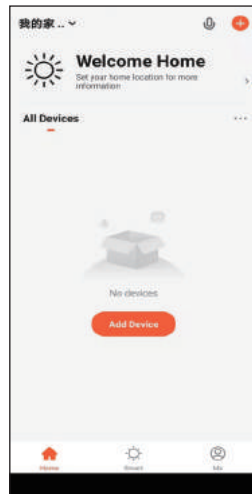

③:Enter WiFi and Password (2.4Ghz)

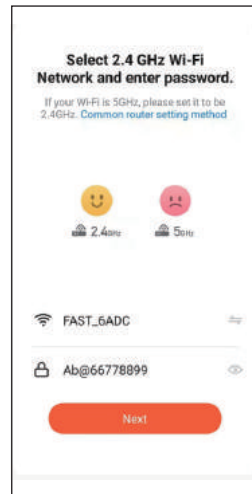

④:Choice EZ Mode press Next

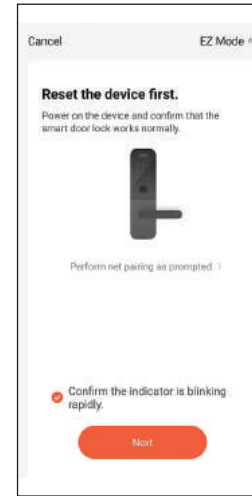

⑤:Added successfully



⑥:Press Doorbell for requesting remote unlock.



⑦:Press Doorbell for requesting remote unlock.

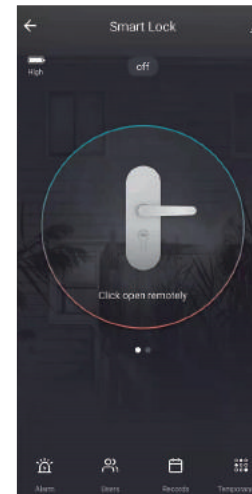

⑧: Create dynamic password

